

DECK SYSTEMS

ELEVATE YOUR OUTDOORS



a history of innovation

SINCE THE FIRST PROTOTYPE WAS DESIGNED in 2009, Mbrico Tile Decks has redefined passion, innovation, and engineering in the decking industry. Our experience in construction and home building led us to create a luxurious yet simplistic groutless tile deck system that integrates beautifully into any design.

As the industry's first comprehensive and ready-to-install decking that's not matched by any other product on the market, our superior system features a better design with easier installation, lower maintenance, and more color options than other conventional decking solutions.



proprietary & revolutionary system

THE MBRICO TRACK SYSTEM AND BACKER is a turnkey solution for upgrading traditional elevated decks. It's easily installed by any skilled carpentry crew that is building a new deck or resurfacing existing framing.

Mbrico Tile Decks utilize a tongue and groove track system that is completely self-spacing and free draining. Designed with the installer in mind, our track system is laid over the top of standard treated lumber, steel, or aluminum joists. It provides a straight line, self-leveling extrusion that guarantees perfect spacing and flawless installation every time.

The secret to the Mbrico system's success lies in the tile backer. Designed to work seamlessly with our entire system, we use a proprietary bonding process on our porcelain tiles so that they are a perfect fit with our aluminum tracks. Typically, unbacked 2cm tiles cannot be installed on an elevated surface due to safety

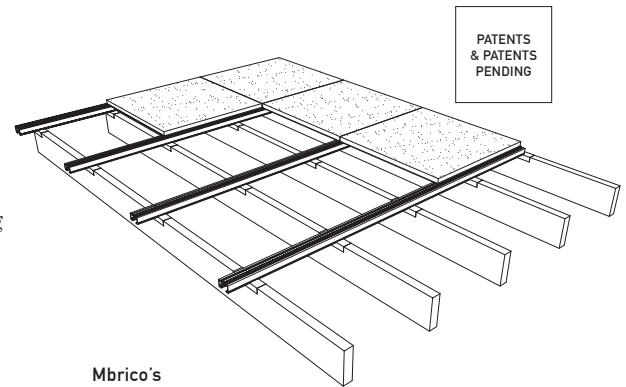

Mbrico's revolutionary track system applies to standard deck framing

concerns. Our revolutionary backer pushes the envelope with a better design, rigorous testing, and a safer product for our customers.

To get started, all you need are our beautiful porcelain tiles, aluminum tracks, deck screws, butyl tape, and traditional code deck framing. It's simple, yet impactful.

Mbrico works in perfect harmony with all of the industry's popular railing solutions, adaptable to surface or fascia-mounted railings with tile waterfall edges, composite picture frame borders, or flush fascia boards.



designed for life



A COMBINATION OF AMERICAN CRAFTSMANSHIP, high-quality Italian stoneware, and ground-breaking technology provide a myriad of advantages to create the most durable indoor/outdoor surfaces.

ANTI-SLIP - Mbrico Tile Deck surfaces are ADA-compliant, skid-resistant, and textured to prevent slipping, even when wet.

EASY INSTALLATION - Ready to install, each component is precision cut for accurate coupling of slabs. Our grout-free and self-spacing system makes installation remarkably easy for skilled carpentry crews using mechanical fasteners and standard tools. No painting, staining or sealing is required— ever.

WEIGHT LOADS - Each porcelain slab can bear a load of up to 5,300 lbs, making Mbrico Tile Decks one of the strongest decking options on the market. Other materials like grouted stone, concrete, or wood may crack under heavy loads, causing unsafe conditions and becoming a liability.

DURABILITY - Our porcelain tiles won't rot, mold, warp, stain, crack, splinter, crumble or fade. They're also resistant to expansion and contraction issues, gapping, and movement.

FROST PROOF - Tested by Tile Council of North America for 60 years worth of freeze/thaw cycling with no visible change. Installed from Northern British Columbia to Barbados.

INTERIOR AND EXTERIOR APPLICATION - Our beautiful tile can become the heart of your home or business as the high-quality Italian stoneware seamlessly flows between interior and exterior spaces.

AFFORDABLE - No more expensive outsourcing, importing from overseas, or extended lead times. This is the most cost-effective tile decking surface the industry has ever seen.

SUSTAINABLE - Built to meet LEED standards, our tile is made without harmful chemicals, varnishes, and resins and is designed to last a lifetime reinforcing our commitment to sustainability.

DESIGNED TO THE DETAIL - Whether you have detailed architectural plans or a concept on a napkin, our talented design team elevates each project to unique levels of luxury and longevity.

WARRANTY - Residential and commercial customers enjoy a limited lifetime warranty.



When I found Mbrico, I knew we had something of a completely different caliber here that would solve the concerns I have had with other outdoor installations.”

- Mike Byron, MCNE CRS
Managing Broker, John L. Scott Real Estate

RESISTANCE - Each of our materials is resistant to mold, stains, frost, flames, chemicals, extreme temperatures and more.

LONGEVITY - Mbrico tile decks are designed to last. Our products are exposed to harsh elements every day and still have a lifespan of over 30 years.



global partners



USA's Largest Wholesale Distributor of Building Products



ESTATES BY JEFFREY COLLÉ

The Hamptons preeminent home design builder and innovator.



SHERATON

Accommodations that transform spaces to focus on connection.



AMERICA'S LUXURY HOME BUILDER

#1 Home Builder on the Fortune Magazine 2022 World's Most Admired Companies list.



Captivating lifestyle hotels with heartfelt designs and style.

italian inspired american made

 **ALL THE BEAUTY AND DURABILITY** of luxury Italian porcelain tile with the affordability and convenience of a domestic product.

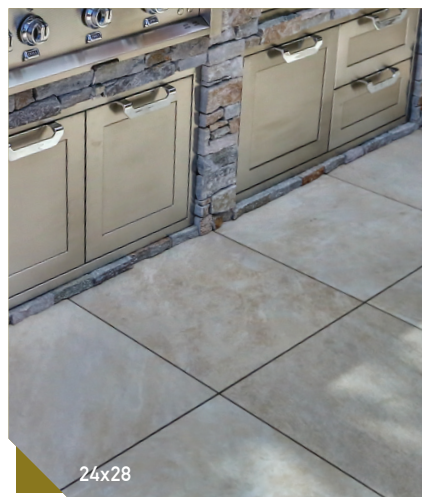
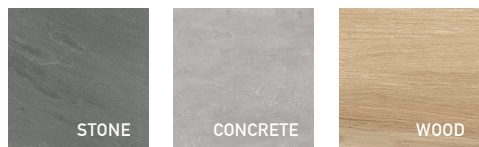
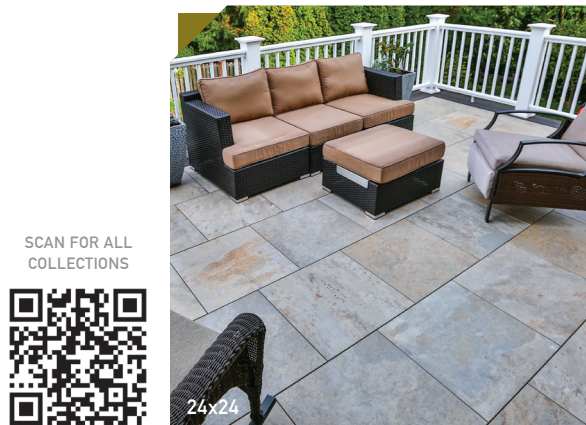

MBRICO CAN EASILY SATISFY ANY TASTE with over 60 color and pattern options available in wood, stone, aggregate, plank, and large-format tiles. Choose from four standard sizes that allow you to customize your look.

| | MBRICO | COMPOSITE AND PLASTIC | CONCRETE PAVERS | GROUTED TILE AND STONE | PVC AND VINYL | WOOD |
|------------------------------|--------|-----------------------|-----------------|------------------------|---------------|------|
| EASY TO INSTALL | ■ | | | | | ■ |
| EASY TO CLEAN | ■ | ■ | | ■ | | |
| STAIN RESISTANT | ■ | | | | ■ | |
| CHEMICAL RESISTANT | ■ | ■ | | ■ | | |
| MOLD AND MOSS RESISTANT | ■ | | | | ■ | |
| TERMITE AND INSECT RESISTANT | ■ | ■ | | | ■ | |
| FLAME RESISTANT | ■ | | ■ | ■ | | |
| FROST RESISTANT | ■ | | ■ | | ■ | |
| THERMAL SHOCK RESISTANT | ■ | | | | ■ | ■ |
| WIND UP-LIFT RESISTANT | ■ | | ■ | | ■ | ■ |
| SCRATCH AND DENT RESISTANT | ■ | | ■ | ■ | ■ | |
| ANTI-SLIP | ■ | ■ | | | ■ | |
| HIGH WEIGHT CAPACITY | ■ | ■ | | | ■ | |
| CHROMATIC STABILITY | ■ | | | ■ | | |
| INDOOR/ OUTDOOR | ■ | | | ■ | | |

“ Great customer service, great communication & most importantly, the product is fantastic.

- Brett Webber
Senior Vice President, Colliers International

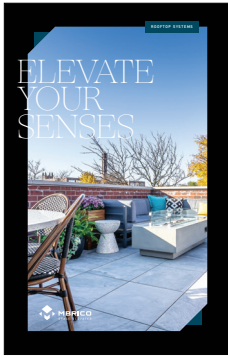

rooftops

MBRICO IS PROUD TO PRESENT THE industry's first complete, safe, and easy-to-install porcelain tile flat-roof and pedestal system. No height restrictions. No shatter liability. No fear of wind. The sky's the limit with Mbrico rooftops and raised floors.

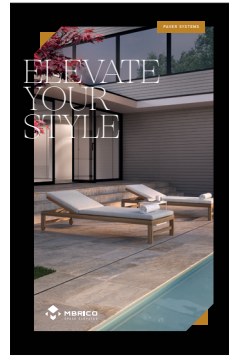

pavers

MBRICO OFFERS A FULL LINE OF traditional hardscaping and landscaping pavers. A luxurious combination of American craftsmanship, Italian tile, and groundbreaking technology, we create performance surfaces so you can experience the ultimate outdoor living pleasure.

certifications and awards

2022 National Association of Home Builders "Best Outdoor Product" Finalist

2019 National Association of Home Builders IBS Show Global Innovation Winner

2016 Best of IBS Finalist - NAHB International Builders' Show

2016 Minneapolis Home + Garden Show Innovation Avenue Winner

2016 NADRA National Deck Competition Award - People's Choice - Product Manufacturer

2016 NAHB Green Building Young Professional of the Year Nominee

2016 This Old House Magazine Editor's Pick

2015 NADRA National Deck Competition Award - People's Choice - Product Manufacturer



Mbrico Tile Decks
P.O. Box 1108
Bettendorf, Iowa 52722

1-844-449-9214
info@mbricotiledecks.com
www.mbricotiledecks.com

