

COPING & STAIR TREAD MONOLITHIC. A UNIQUE PIECE, A THOUSAND SOLUTIONS.

_Coping & Stair Tread Monolithic* is processed in order to cater to multiple needs in outdoor design. **Two different border shapes**, bullnose (rounded) border and rectified border, in one single piece: freedom for projects with the excellent technical performance of porcelain stoneware.

**BULLNOSE
BORDER**



**RECTIFIED
BORDER**



DESTINATION OF USE.

- STAIRS
- POOLS

_A trim piece offering outstanding versatility, both in terms of look and efficiency. Thanks to its two different border shapes, Coping & Stair Tread Monolithic is suitable both for **swimming pool copings** and for **stairs**, in two different versions: with or without grip strips.



* Coping & Stair Tread Monolithic is available in the following colors: Barge Gold, Multicolor Gold, Silver Quartz, Vintage Slab.

STAIRS WITH AN IN-DEMAND AESTHETIC THAT IS ALSO HIGH PERFORMING.

SYSTEM.

- STAIR TREAD
- GRIP STAIR TREAD
- RISER

ADVANTAGES.

- RESISTANCE TO SALTS
- RESISTANCE TO CHEMICALS
- TECHNICAL PERFORMANCE
- ANTI-SLIP
- VISUAL CONTINUITY TO THE OUTDOOR FLOOR

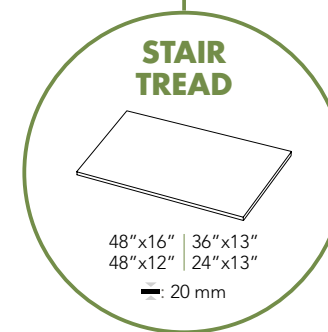
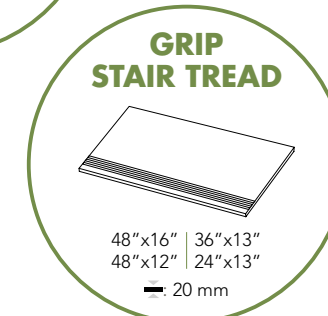
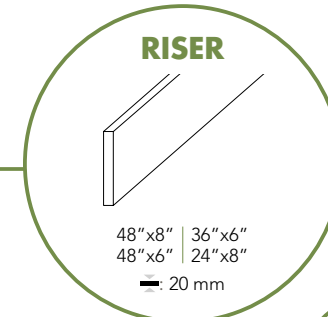

COMFORT AND STYLE FOR SWIMMING POOL AREAS.

SYSTEM.

- LINEAR COVER DRAIN SET
- COPING
- COPING CORNER

ADVANTAGES.

- RESISTANCE TO SALTS
- RESISTANCE TO CHEMICALS
- ANTI-SLIPPERINESS
- DURABILITY
- EASY TO CLEAN
- VISUAL CONTINUITY TO THE OUTDOOR FLOOR

* The Linear Cover Drain Set is made-up of two pieces, each having a further beveled and polished edge. The two pieces are studied to be laid with the beveled and polished edges facing each other in order to create an open joint. See pages 37, 38, 39, 40 for more details.

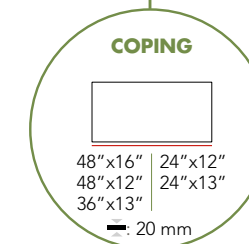
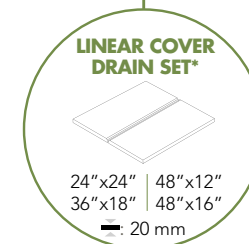
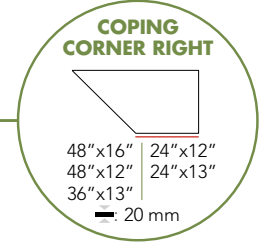
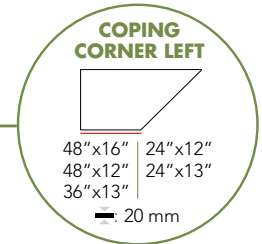
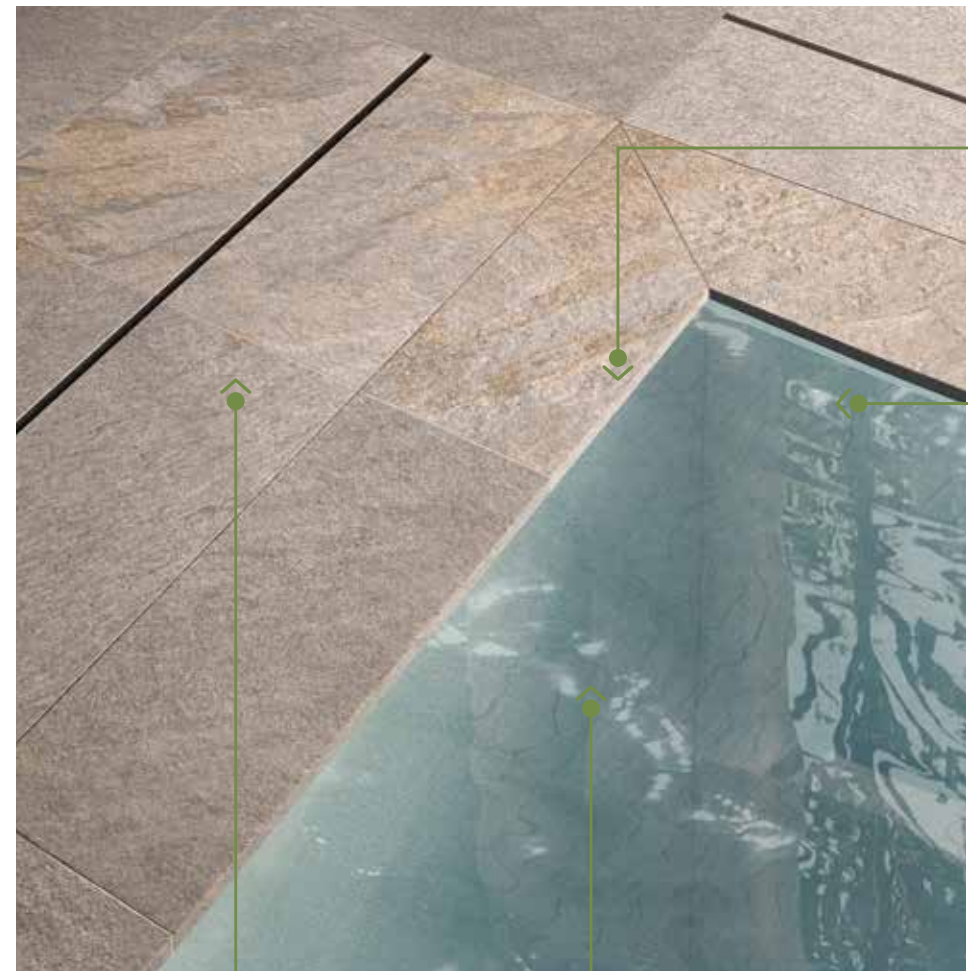

WALL COVERS: PROTECTION FROM WATER AND VISUAL CONTINUITY.

SYSTEM.

- COVER
- END-COVER

ADVANTAGES.

- ANTI-DETERIORATION
- EASY TO CLEAN
- PROTECTS THE WALL FROM WATER INFILTRATION



COVER*



36"X12"
12"x24"
— 20 mm

END COVER*



36"X12"
12"x24"
— 20 mm

DRIPSTONE

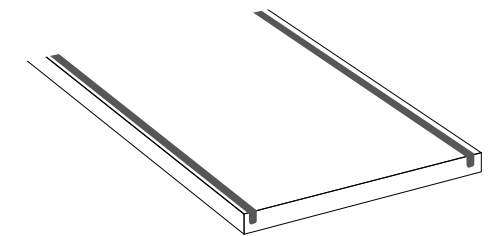

* Both Cover and End-Cover have dripstone and undecorated borders.

TRIM TILES RANGE 24"x24"

STAIRS

STAIR TREAD
MONOLITHIC**

TRIM DIMENSIONS

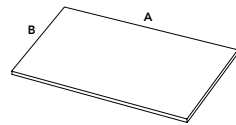

A: 24"
B: 13"

GRIP STAIR TREAD
MONOLITHIC**

TRIM DIMENSIONS

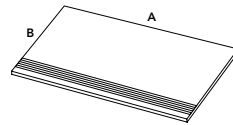

A: 24"
B: 13"



Grip on rectified side | Grip on bullnose side

STAIR TREAD*

TRIM DIMENSIONS

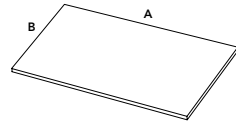

A: 24"
B: 13"

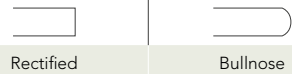

Rectified | Bullnose

GRIP STAIR TREAD*

TRIM DIMENSIONS

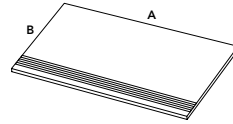

A: 24"
B: 13"

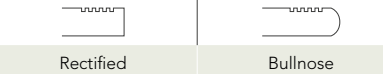

Rectified | Bullnose



* Available in standard version (with undecorated borders).

** Monolithic trim pieces (with decorated borders), available in the following colors:
Barge Gold, Multicolor Gold, Silver Quartz, Vintage Slab.

TRIM TILES RANGE 24"x24"

POOLS

COPING
MONOLITHIC**

TRIM DIMENSIONS

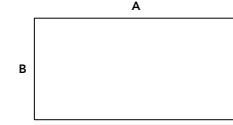

A: 24"
B: 13"

Only bullnose border

COPING CORNER
MONOLITHIC**

TRIM DIMENSIONS

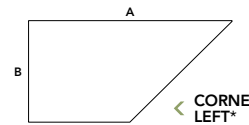

CORNER
LEFT*

A: 24"
B: 13"

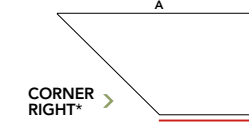

CORNER
RIGHT*

Only bullnose border

COPING*

TRIM DIMENSIONS

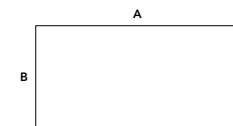

A: 24"
B: 13"

A: 24"
B: 12"



Rectified | Bullnose

COPING CORNER*

TRIM DIMENSIONS

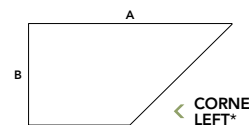

CORNER
LEFT*

A: 24"
B: 13"

A: 24"
B: 12"

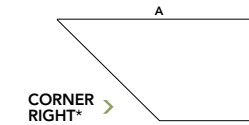

CORNER
RIGHT*



Rectified | Bullnose

LINEAR COVER
DRAIN SET*

TRIM DIMENSIONS

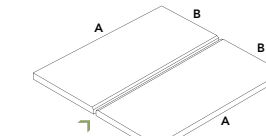

OPEN JOINT
WIDTH 0,28" (1/32")

A: 24"
B: 11,63"



Open joint width 0,28" (1/32")



* Available in standard version (with undecorated borders).

** Monolithic trim pieces (with decorated borders), available in the following colors:
Barge Gold, Multicolor Gold, Silver Quartz, Vintage Slab.

WALL COVERS

COVER*

TRIM DIMENSIONS

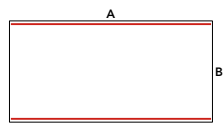

A: 24"
B: 12"

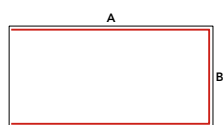

END COVER*



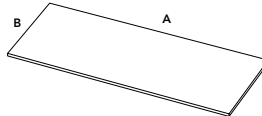
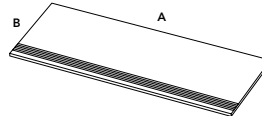

Undecorated border and dripstone

TRIM TILES RANGE 18"x36"

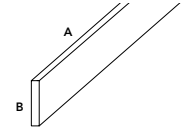

STAIRS

STAIR TREAD*	TRIM DIMENSIONS	GRIP STAIR TREAD*	TRIM DIMENSIONS
	A: 36" B: 13"		A: 36" B: 13"
			
	Rectified Bullnose		Rectified Bullnose

STAIRS

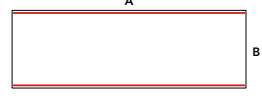

RISER*	TRIM DIMENSIONS
	A: 36" B: 6"
	
	Rectified



WALL COVERS

COVER*	TRIM DIMENSIONS
	A: 36" B: 12"
	
	Undecorated border and dripstone

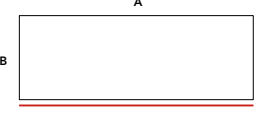
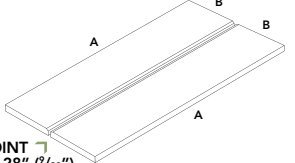
END COVER*	TRIM DIMENSIONS
	

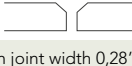
POOLS

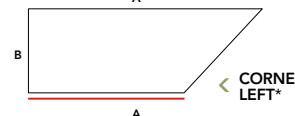

COPING*	TRIM DIMENSIONS	LINEAR COVER DRAIN SET*	TRIM DIMENSIONS
	A: 36" B: 13"		A: 36" B: 8,71"
			
	Rectified Bullnose		Open joint width 0,28" (1/32")

COPING CORNER*	TRIM DIMENSIONS
	A: 36" B: 13"
	
	
	Rectified Bullnose

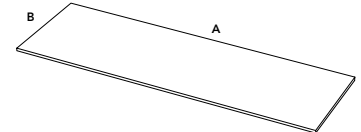
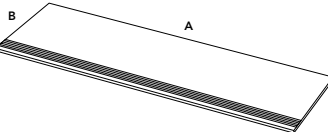

* Available just in standard version (with undecorated borders)

TRIM TILES RANGE 12"x48"

STAIRS

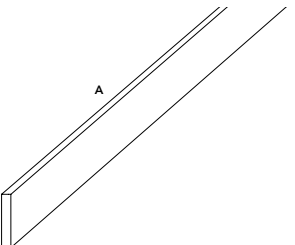

STAIR TREAD*	TRIM DIMENSIONS	GRIP STAIR TREAD*	TRIM DIMENSIONS
	A: 48" B: 12"		A: 48" B: 12"
			
	Rectified Bullnose		Rectified Bullnose

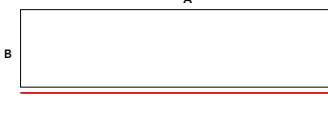
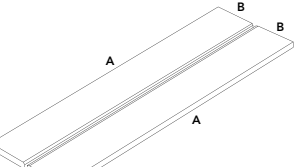
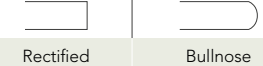
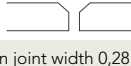

RISER*	TRIM DIMENSIONS
	A: 48" B: 6"
	
	Rectified

POOLS

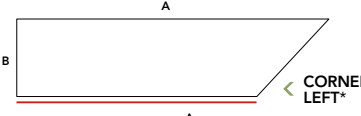
COPING*	TRIM DIMENSIONS	LINEAR COVER DRAIN SET*	TRIM DIMENSIONS
	A: 48" B: 12"		A: 48" B: 5,76"
			
	Rectified Bullnose		Open joint width 0,28" (1/32")

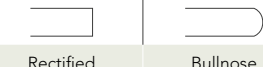
COPING CORNER*	TRIM DIMENSIONS
	A: 48" B: 12"
	
	
	Rectified Bullnose

* Available just in standard version (with undecorated borders)

TRIM TILES RANGE 16"x48"

STAIRS

STAIR TREAD*

TRIM DIMENSIONS
A: 48"
B: 16"

Rectified | Bullnose

GRIP STAIR TREAD*

TRIM DIMENSIONS
A: 48"
B: 16"

Rectified | Bullnose



RISER*

TRIM DIMENSIONS
A: 48"
B: 8"

Rectified

POOLS

COPING*

TRIM DIMENSIONS
A: 48"
B: 16"

Rectified | Bullnose

LINEAR COVER DRAIN SET*

TRIM DIMENSIONS
A: 48"
B: 7,73"

Open joint width 0,28" (1/32")

COPING CORNER*

TRIM DIMENSIONS
A: 48"
B: 16"

Rectified | Bullnose

* Available just in standard version (with undecorated borders)

